

1

2

3

4

5

6

A

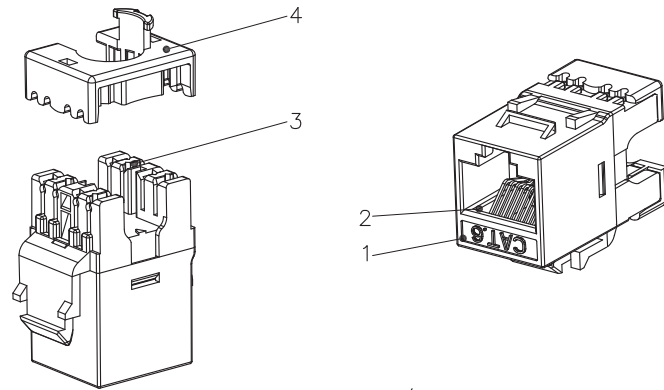

SCALE 1/1

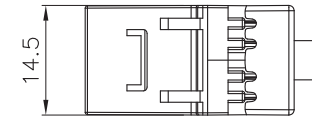

B

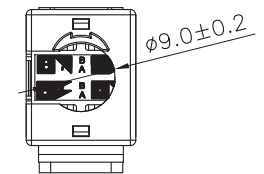
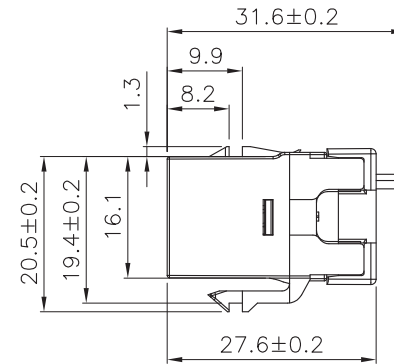
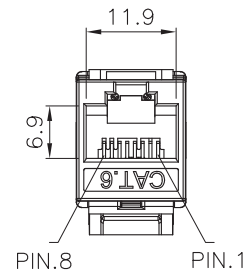

A

B

C

D

Specification :

Material :

1. RJ45 Jack :

- 1-1. Housing : ABS+PC, UL 94-V0, with optional color.
- 1-2. Contact Bracket : PC, UL 94-V2, Transparent color.

2. RJ45 Jack Contact :

- 2-1. Material : Phosphor Bronze with Nickel plated.
- 2-2. Finish : 50 micro-inch Gold plated on Plug contact area.

3. IDC :



- 3-1. Housing : PC+Glass Fiber, Grey color(RAL7035), UL 94V-2.
- 3-2. Terminal : Phosphor Bronze with Tin plated.

4. IDC Cap : PC+Glass Fiber, UL 94-HB, White color.

5. PCB : FR4, UL 94V-0.

Performance :

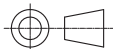
- a. T568A & T568B wiring.
- b. Insertion Force : 20N max. (IEC 60603-7-4).
- c. Retention Strength : 7.7 kg between Jack and Plug.
- d. Operating Temperature : -10°C to 60°C. (ISO/IEC 11801, ANSI/TIA 568 C.2).
- e. Life(mating cycles) :
 - e-1. Jack : 750 cycles min. (ISO/IEC 11801, IEC 60603-7-4.)
 - e-2. IDC : Suitable for 23-26 AWG solid wire, compatible with both 110 & Krone punch down tools.
- f. The Cat.6 transmission performance is in compliance with the ANSI/TIA 568 C.2 standard.

| | | | | |
|---------------------------------------------------------------------------------------|----------|---------------------------------------------------------------------------------------|-------|---------------------------------------------------------------------------------------|
| GENERAL TOLERANCE OF DIMENSIONS X.XXX ±0.005 X.XX ±0.05 X.X ±0.1 | DRAWING | 16.FEB.2016 | CHP |  |
| | CHECK | 16.FEB.2016 | DAY | |
| | APPROVAL | 16.FEB.2016 | JAIMY | |
| | DATE | | NAME | |
| SCALE | 1/1 (A4) | UNIT | mm | DES.: CAT.6 FULL UNSHIELDED KEYSTONE JACK |
| DRAWING NO. AADDC01114000XX KJ28-C6-US-XX(SA3) | | DRAWING CLASSIFICATION | | S SHEET 1 OF 1 |
|  | |  | |  |

1

2

0

3

4

10cm

5

6